

SAFETY & STATE EYE

Easy to recognize the boiler status and situation at first sight!

SAFETY EYE Real time indication of boiler operation condition

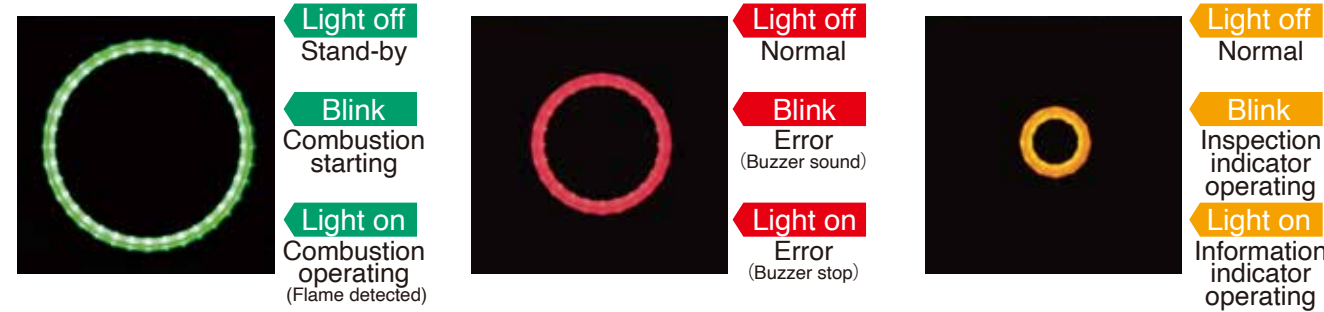

STATE EYE Real time indication of combustion state and water level condition

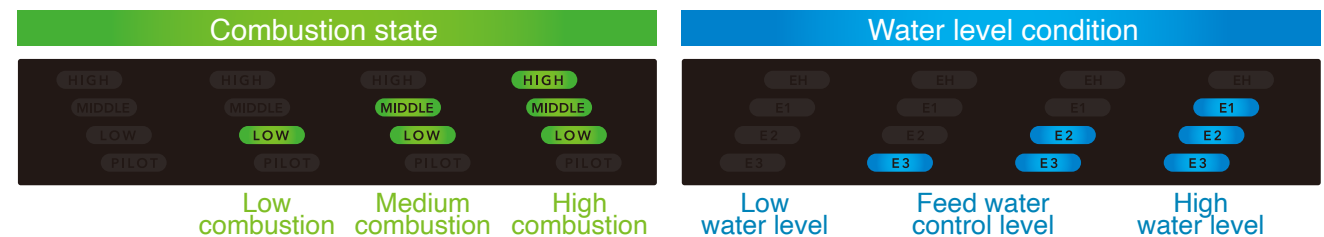

Status and settings such as steam pressure and water conductivity are displayed in an easy-to-understand manner (in Japanese or English).

Multiple safe design

Fail safe

Installed multiple safe device as low water cut off device, safety valve etc. More high level safeness with fail safe design feed water control and combustion control. High reliability with equipped sensors.

- Gas pressure switch
- Wind pressure sensor
- Steam pressure sensor
- Exhaust gas temperature sensor *
- Boiler body thermo
- Electric conductivity sensor
- Boiler water temperature sensor
- etc * : Option

Prevention method

Check points would be informed on the monitor before the error occurs.

- Steam pressure sensor inspection
- Chemical injection pump inspection
- Exhaust gas temperature sensor inspection *
- Electric conductivity sensor inspection
- Water tube temperature sensor inspection
- Overall blowdown inspection (Automatic overall blowdown device) *
- Water-level electrode rod inspection
- Concentrated blowdown inspection
- High water level sensor inspection (Pure water specification) * etc * : Option

Durable boiler body structure

Boiler body has the furnace with round-positioned water tube. Heat from combustion gas is transferred to each water tube equally. No particular water tube is overheated so that you can enjoy long-life of boiler.

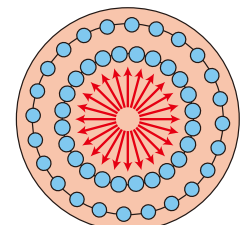

Cross-section of boiler body

Multiple safe design

Boiler body thermo switch, steam temperature sensor, earthquake detector and etc. are installed as standard as enforced safety device.

Network

We, SAMSON Co., Ltd., have been engaged in the manufacture and sales of various Boilers and Food Processing Equipment since our foundation in 1945, and have been enjoying a good reputation from customers in various industrial fields of Japan.

In overseas markets, we have devoted ourselves to exporting our products into mainly Asian countries for a long period and have delivered them to many customers.

After delivery, our authorized distributors in the respective countries have taken care of maintenance services on our equipment through the cooperation from customers.

We are supporting our distributors for the improvement of maintenance technology and we hope our customer can operate our products safely without any trouble.

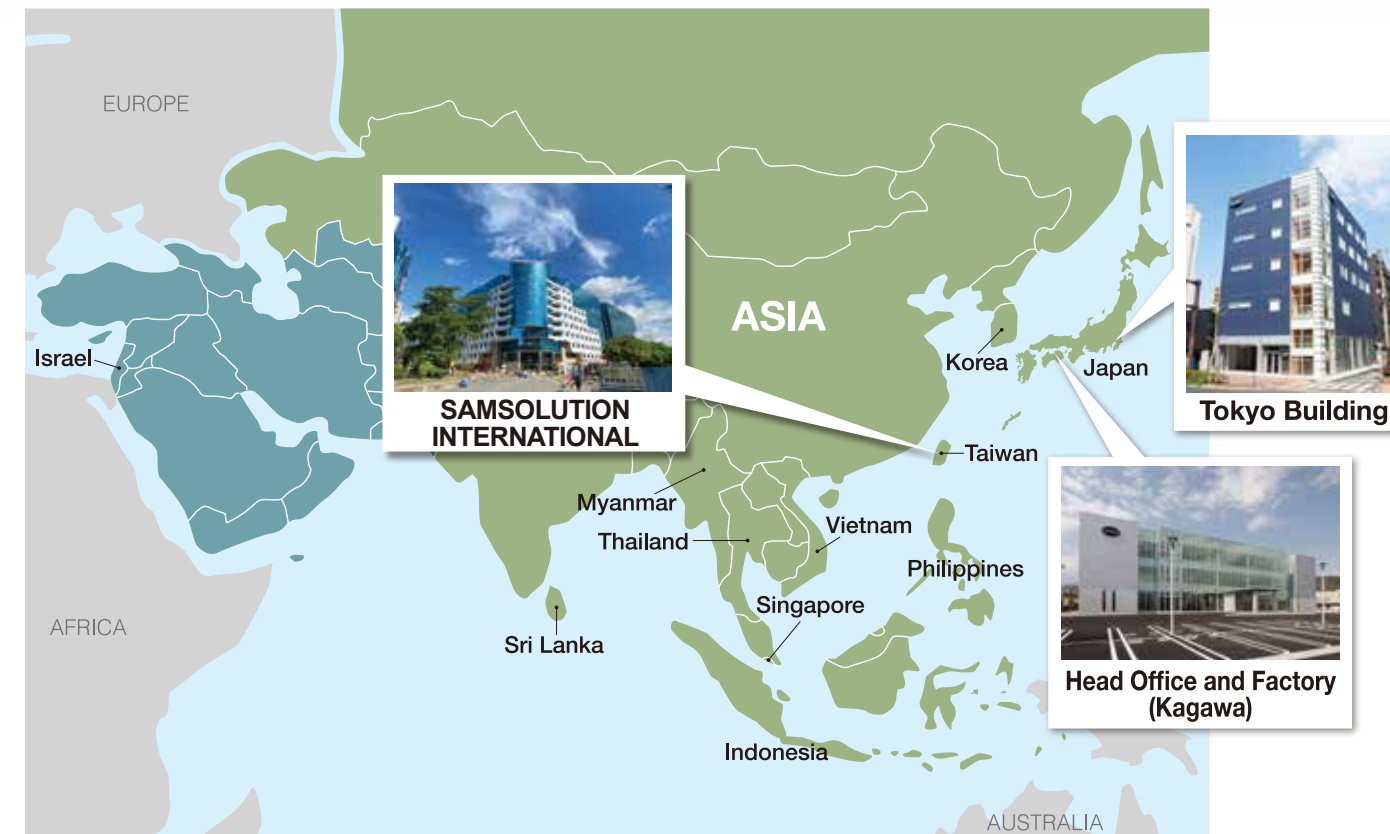

SAMSON CO.,LTD.

Tokyo Building(International Division)

ADDRESS	1-4-1 Omori-honcho, Ota-ku, Tokyo 143-0011 Japan
T E L	+81-3-6423-1171
F A X	+81-3-3761-0342
E - M A I L	overseas@samson.co.jp
WEB SITE	https://www.samson.co.jp/en/

SAMSOLUTION INTERNATIONAL CO., LTD.

ADDRESS	7F-8, NO.12, LN.609, SEC.5,CHONGXIN RD., SANCHONG DIST., NEW TAIPEI CITY 24159, TAIWAN(R.O.C.)
T E L	+886-2-2278-3636
F A X	+886-2-2278-3535
WEB SITE	https://www.samson.co.jp/tw/

SAMSOLUTION

For a sustainable future of energy and food

SAMSOLUTION BOILER SYSTEM

BB-AG, BB-APG series

Once Through Boiler・Small Type Boiler GAS

Made in Japan since 1945

BOOSTER BOILER

BB-750AG・750APG
-1000AG・1000APG
-1500AG・1500APG



SAVING ENERGY & ENVIRONMENT-FRIENDLY

High efficiency

Improved boiler efficiency reduces fuel consumption and CO₂ emissions.

Boiler efficiency

90%

For models with economizer

Boiler efficiency

97%

Environment-Friendly

LOW NO_x burner is installed as standard

Low NO_x 40ppm or less

Condition: O₂ = 0% value, 13A actual measure: room temp. 30°C, humidity 65%. NO_x value changes by fuel condition, room temp., and humidity.

Burner type is nozzle mix. No air filter needed, no trouble with daily maintenance for filter check / cleaning.

Economic efficiency

Inverter is installed as standard

1/4 reduction of electric consumption at low combustion

Improved Turn down ratio

1:2 → 1:4

1:4 wide combustion, saving energy operation with few stand-by!

Boiler efficiency improved at low load!

4 Position control

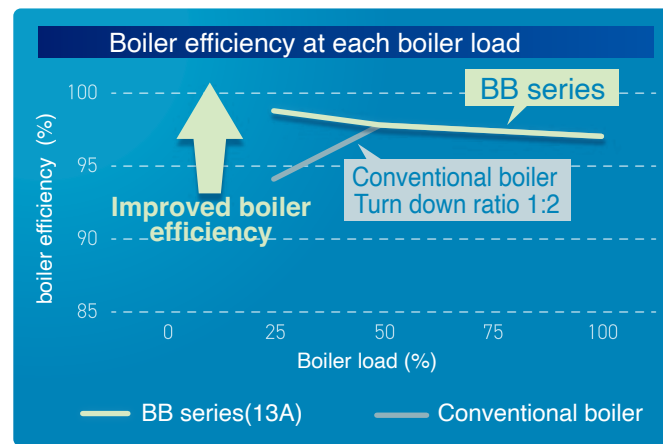

*BB-750AG/APG is 3-position control

Saving energy

with High dryness steam [measured value more than 99.5%]

- Advanced water level control system helps to obtain stable supply of high dryness steam.
- If steam with high heating value (High dryness steam) is used, steam consumption can be reduced. Consequently, fuel expenses can be reduced.

For example, if the steam dryness is 1.5% higher, steam heating value is increased in 1.5% which means you can save the energy consumption.

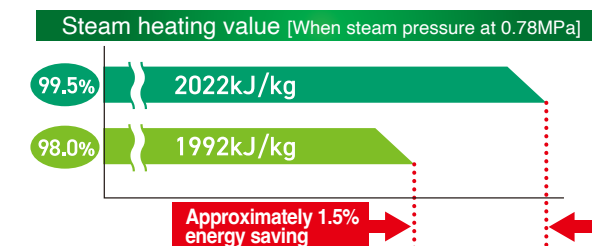
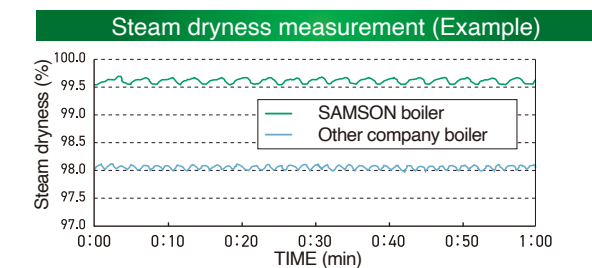

SYSTEM FLOW

We, SAMSON CO., LTD., propose and support total system of boiler and the related equipment for the benefit of our customers and the most suitable operation.

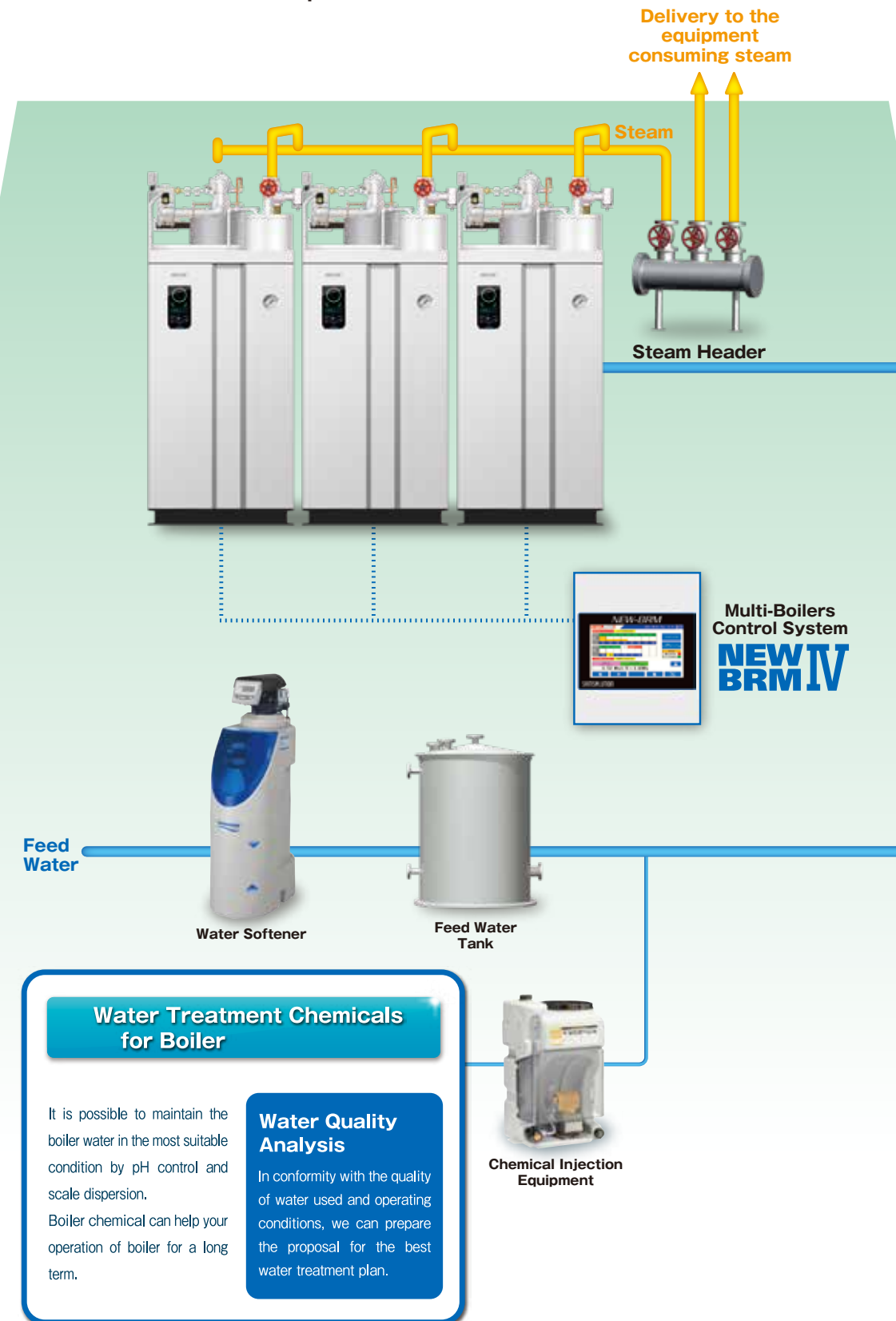

Water Treatment Chemicals for Boiler

It is possible to maintain the boiler water in the most suitable condition by pH control and scale dispersion. Boiler chemical can help your operation of boiler for a long term.

Water Quality Analysis

In conformity with the quality of water used and operating conditions, we can prepare the proposal for the best water treatment plan.

Specifications

Item	Unit	BB-750AG	BB-750APG	BB-1000AG	BB-1000APG	BB-1500AG	BB-1500APG
Type of Boiler	—	Once-Through Boiler		Small Type Boiler			
Max. Pressure	MPa	0.98					
Working Pressure Range	MPa	0.49~0.88					
Hydraulic Testing Pressure	MPa	1.58					
Equivalent Evaporation	kg/h	750		1,000		1,500	
Heat Output	kW(kcal)	470(404,000)		627(539,000)		940(809,000)	
Boiler Efficiency	%	90	97	90	97	90	97
Heating Surface Area	m ²	4.98		9.85		9.75	
Holding Water Volume	L	90		160		155	
Type of Burner	—	Blast					
Combustion Control	LPG	3-Position control (Fan motor : Inverter control)			4-Position control (Fan motor : Inverter control)		
Turn-down Ratio	LPG	1:4					
Feed Water Control	—	ON-OFF control					
Ignition	—	AC Spark Ignition					
Fire Detection	—	Ultraviolet Ray Phototube					
Dry Weight	kg	950	1,150	1,360	1,610	1,390	1,700
Weight in Operation	kg	1,040	1,250	1,520	1,790	1,550	1,880
Fuel Consumption	13A	46.3	43.0	61.8	57.3	92.7	86.0
	LPG	20.1	18.6	26.8	24.8	40.1	37.2
	Propane	40.5	37.6	54.0	50.1	81.1	75.2
	LPG	15.8	14.7	21.1	19.6	31.6	29.4
	Butane	41.2	38.2	54.9	50.9	82.3	76.4
Supply Gas Pressure	13A kPa	2.0±0.5			13.0~20.0		
	LPG kPa	2.8±0.5			8.0~15.0		
Supply Power Available Electricity	—	AC200V 3φ (50/60Hz)					
Equipment Power	kW	3.2		3.9		7.9	
Total Electric Capacity	kVA	7.8		8.6		14.5	
Description	Fan Motor	1.5		2.2		5.5	
	Feed Water Pump Motor	1.5		2.2		2.2	
	For Control	1.5		0.2		2.2	
Main Wire Size	mm ²	3.5		5.5		14	
Power Breaker Capacity	A	30		40		60	

Remarks: 1. The performance display conforms to the "Boiler performance display reference value" of Small-Type Once Through Boiler Association of Japan. The calculation conditions are as described below.

Calculation condition of boiler efficiency
 Heating balancing : JIS B 8222
 Steam pressure : 0.49MPa
 Water supply temperature : 15°C
 Charge air temperature : 35°C
 Lower heating value = 13A : 40.6 MJ/m³(N)
 = LPG Propane : 93.7 MJ/m³(N), 46.4MJ/kg
 = LPG Butane : 118.9 MJ/m³(N), 45.7MJ/kg

- The allowable values below shall be provided as an error.
 -BB-750 error of boiler efficiency ±2%
 -BB-1000-1500 error of boiler efficiency ±1%
 -Error of combustion quantity (input) ±3.5%
- A power supply of 100 V AC (1φ) is required when installing a water softener.
- Gas booster pump is required when the supply gas is insufficient.
- 5.NO_x guaranteed value: 60ppm (Condition: O₂ = 0% value, 13A, room temp. 30 °C, humidity 65%. NO_x value changes by fuel condition, room temp., and humidity.)
- Please contact us if you would like to use the steam pressure more than 0.88MPa.

Outline Dimensions

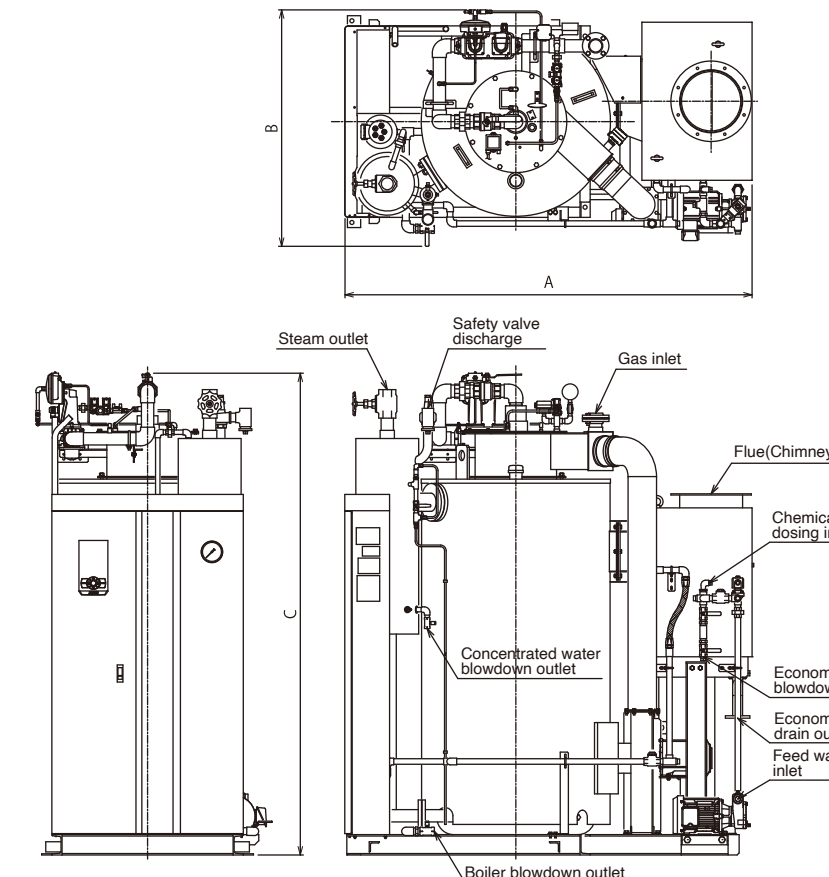

The shape of boiler is different depending on Model and Specification. This drawing is BB-1000APG

Table of Dimensions

	BB-750AG	BB-750APG	BB-1000AG	BB-1000APG
A (Length)	1,783	1,917	2,099	
B (Width)	966	1,060	1,132(13A) 1,161(LPG)	
C (Total height)	1,934		2,370	
Feed water inlet	25A(Rc1)			
Gas inlet	50A(Rc2)			
Steam outlet	32A(Rc1-1/4)		50A(Rc2)	
Safety valve discharge	32A(Rc1-1/4)		40A(Rc1-1/2)	
Boiler blowdown outlet	25A(Rc1)			
Concentrated water blowdown outlet	15A(Rc1/2)			
Chimney drain outlet	32A(Rp1-1/4)	—	32A(Rp1-1/4)	
Economizer blowdown	—	20A(Rc3/4)	—	20A(Rc3/4)
Economizer drain outlet	—	40A JIS5K	—	40A JIS5K
Chemical dosing inlet	15A(Rc1/2)			
Flue(Chimney)	φ250	φ250 Flange connection or insertion connection	φ300	φ300 Flange connection or insertion connection

	BB-1500AG	BB-1500APG
A (Length)	2,019	2,313
B (Width)	1,178	1,143
C (Total height)	2,316	
Feed water inlet	32A(Rc1-1/4)	
Gas inlet	50A(Rc2)	
Steam outlet	50A(Rc2)	
Safety valve discharge	50A(Rc2)	
Boiler blowdown outlet	25A(Rc1)	
Concentrated water blowdown outlet	15A(Rc1/2)	
Chimney drain outlet	32A(Rp1-1/4)	—
Economizer blowdown	—	20A(Rc3/4)
Economizer drain outlet	—	40A JIS5K
Chemical dosing inlet	15A(Rc1/2)	
Flue(Chimney)	φ300	φ300 Flange connection or insertion connection

*Product specifications are subject to change without notice for improvement.